

Name: \_\_\_\_\_ Date: \_\_\_\_\_ Event: \_\_\_\_\_ Track: \_\_\_\_\_

**Track Conditions**

<input type="checkbox"/> Indoor	<input type="checkbox"/> Tight	<input type="checkbox"/> Smooth	<input type="checkbox"/> Hard Packed	<input type="checkbox"/> Blue Groove	<input type="checkbox"/> Wet	<input type="checkbox"/> Low Bite	<input type="checkbox"/> High Bite
<input type="checkbox"/> Outdoor	<input type="checkbox"/> Open	<input type="checkbox"/> Rough	<input type="checkbox"/> Loose/Loamy	<input type="checkbox"/> Dry	<input type="checkbox"/> Dusty	<input type="checkbox"/> Med Bite	<input type="checkbox"/> Other

**Front Suspension**

Ride Ht	_____
Camber	_____
Toe	_____
Sway Bar	_____
Notes:	_____

- 0mm
- 1mm
- 2mm

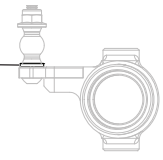

- 0mm
- 1mm
- 2mm

- PI
- 17.5
- Al
- 20

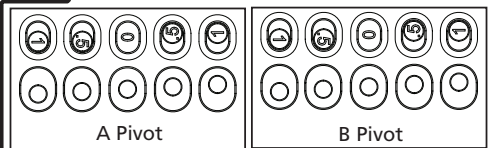
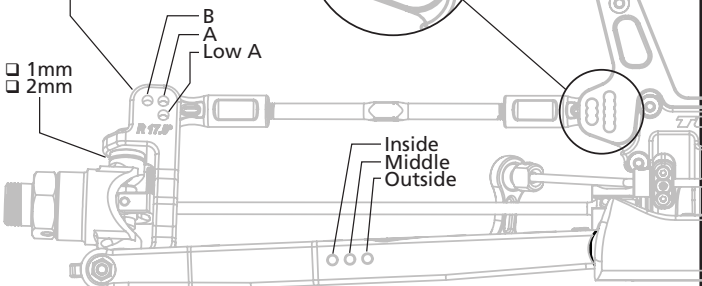

**Rear Suspension**

Ride Ht	_____
Camber	_____
Sway Bar	_____
Notes:	_____

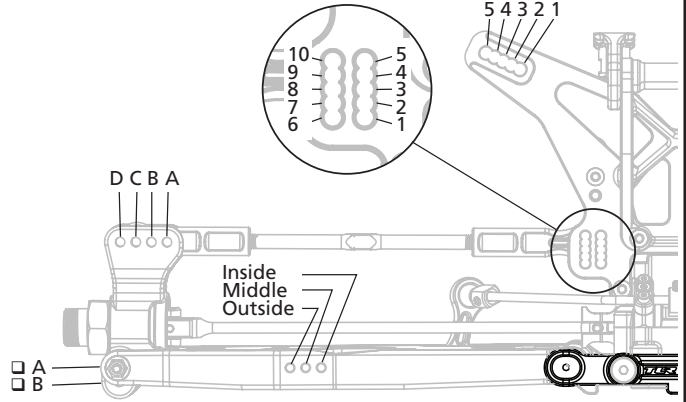
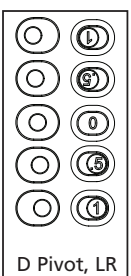
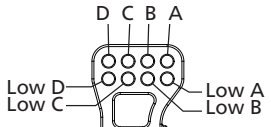

**Chassis**

Differentials	Front	Center	Rear
Fluid			
Pins	<input type="checkbox"/> AL <input type="checkbox"/> STL	<input type="checkbox"/> AL <input type="checkbox"/> STL	<input type="checkbox"/> AL <input type="checkbox"/> STL
Case	<input type="checkbox"/> STD <input type="checkbox"/> HD	<input type="checkbox"/> STD <input type="checkbox"/> HD	<input type="checkbox"/> STD <input type="checkbox"/> HD

**Wing**

Brand \_\_\_\_\_

Wicker Bill

Engine and Clutch	
Engine	Fuel
Glow Plug	Head Clearance
Pipe/Header	Gearing
Clutch Shoes	Clutch Springs
Th Servo	St Servo
Rx Pack	Flywheel <input type="checkbox"/> AL <input type="checkbox"/> STL

Shocks		
	Front	Rear
Shock Type	<input type="checkbox"/> Bladder <input type="checkbox"/> Re Bladder <input type="checkbox"/> Emulsion <input type="checkbox"/> Vented	<input type="checkbox"/> Bladder <input type="checkbox"/> Re Bladder <input type="checkbox"/> Emulsion <input type="checkbox"/> Vented
Shaft Dia	<input type="checkbox"/> 3.5 <input type="checkbox"/> 4.0	<input type="checkbox"/> 3.5 <input type="checkbox"/> 4.0
Piston		
Oil		
Spring		
Stroke		
Droop		

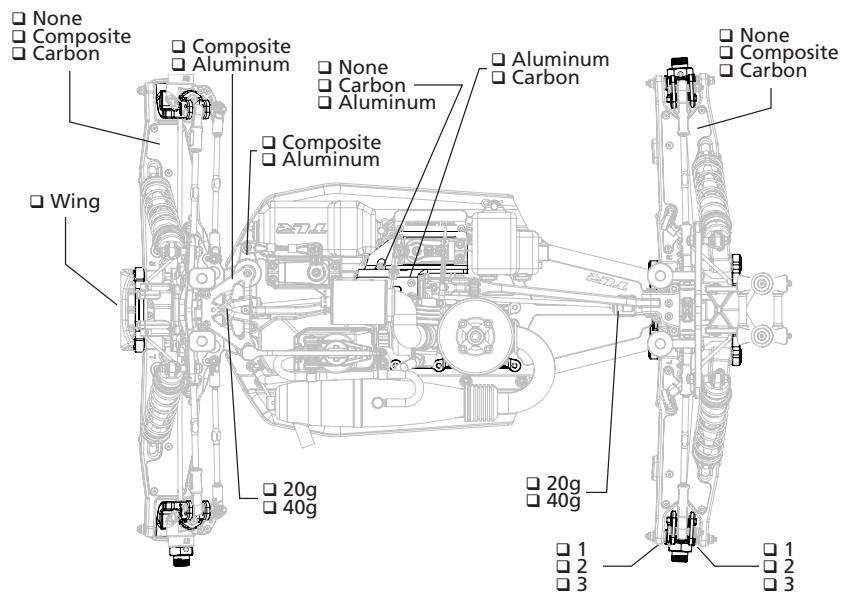

Tires		
	Front	Rear
Brand		
Tread		
Compound		
Insert		
Sauce		